

EXTRA 2

POLYWARM® COATED CALORIFIERS WITH 2 STAINLESS STEEL EXTRACTABLE HEAT EXCHANGERS



APPLICATION

Production and storage of domestic hot water.

MATERIAL

Mild steel Polywarm® coated (Attestation ACS - SSICA - DVGW - W270 - UBA - WRAS)

HEAT EXCHANGER

2 316L stainless steel heat exchangers (upper: straight - lower: Antilegionella® with tubes bent to the bottom).

INSULATION

- HARD: High thermal insulation with ecological polyurethane hard foam.
- SOFT: NOFIRE® polyester fleece 100% made of recyclable material, with high thermal insulation. Fire resistance class B-s2d0 according to EN 13501.

Grey PVC external lining complete with top and flange cover

CATHODE PROTECTION

Magnesium anode. Models > 1500 n° 2 magnesium anode.

DRAIN

External confluence through drain connection.

Models > 1t 1000 external confluence through drain pipe.

GASKET- FLANGE PLATE

Silicone gaskets suitable for alimentary use for max temperature up to 200°C. Mild steel exchanger head with anticorrosion treatment.

WARRANTY

5 years - See general sales conditions and warranty

ACCESSORIES AND SPARE PARTS :

See Accessories section for the entire list.



HARD FOAM INSULATION

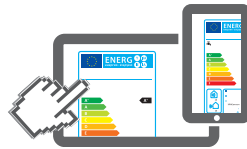

www.cordivari.com/erp

On line ErP label tool

SOFT FLEECE INSULATION

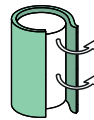

EXTRA 2 WXB

Model	HARD FOAM insulation Art. Nr.	STAINLESS STEEL HEAT EXCHANGER SURFACE		ENERGY EFFICIENCY CLASS
		Lower	Upper	
		[m ²]		
200	3084162360001	0,5	0,5	C
300	3084162360002	0,75	0,75	C
500	3084162360003	1,5	1,5	C
800	3084162360004	2	2	C
1000	3084162360005	3	2	C
1500	3084162360006	3	3	C
2000	3084162360007	4	4	C

EXTRA 2 WXC

Model	DISMOUNTABLE SOFT FLEECE insulation Art. Nr.	STAINLESS STEEL HEAT EXCHANGER SURFACE		ENERGY EFFICIENCY CLASS
		Lower	Upper	
		[m ²]		
500	3082162360133	1,5	1,5	C
800	3082162360134	2	2	C
1000	3082162360135	3	2	C
1500	3082162360136	3	3	C
2000	3082162360137	4	4	C
2500	3082162360113	5	5	
3000	3082162360108	6	6	
4000	3082162360110	8	8	
5000	3082162360112	10	10	

ELECTRICAL IMMERSION HEATERS

Mod.	MONOPHASE		
	1,5 kW	2 kW	3 kW
	Volume of water heated by the electrical immersion [lt]		
200	49		
300	76		
500	127		
800	178		
1000	243		
1500	288		
2000	443		
2500	577		
3000	577		
4000	797		
5000	1040		
	Ignition time from 10 °C to 45 °C with immersion heaters [min]		
	87	65	44
	136	102	68
	228	171	114
	318	239	159
	436	327	218
	516	387	258
	793	595	396
	1033	775	517
	1033	775	517
	1428	1071	714
	1864	1398	932

Mod.	THREEPHASE				
	4 kW	5 kW	6 kW	9 kW	12 kW
	Volume of water heated by the electrical immersion [lt]				
	5240000000047	5240000000048	5240000000049	5240000000050	5240000000031
	Ignition time from 10 °C to 45 °C with immersion heaters [min]				
	//	//	//	//	//
	//	//	//	//	//
	//	//	//	//	//
	//	//	//	//	//
	163	131	109	73	54
	194	155	129	86	65
	297	238	198	132	99
	387	310	258	172	129
	387	310	258	172	129
	535	428	357	238	178
	699	559	466	311	233

Accessories on request

"Easy Control" Electronic Display

ART. NR.	FOR MODELS
5005000310002	WXC
5005000310003	WXB



Titanium electronic anode

See Accessories section



EXTRA 2

POLYWARM® COATED CALORIFIERS WITH 2 STAINLESS STEEL EXTRACTABLE HEAT EXCHANGERS

Model	STORAGE		HEAT EXCHANGER	
	Pmax	Tmax	Pmax	Tmax
200 ÷ 1000	8 bar	90 °C	12 bar	110 °C
1500 ÷ 5000	6 bar			

CORDIVARI Lab
TÜV Rheinland Energie und Umwelt GmbH states that test procedures and Cordivari LAB are certified conforming to European standard EN 15332, as indicated by Ecodesign ErP Directive.

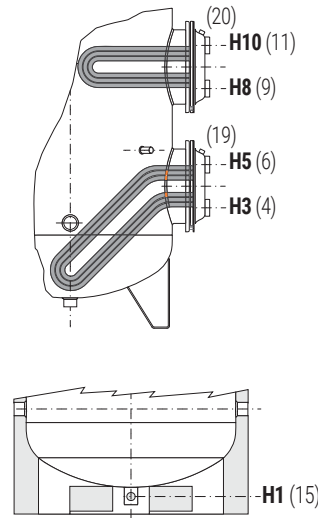
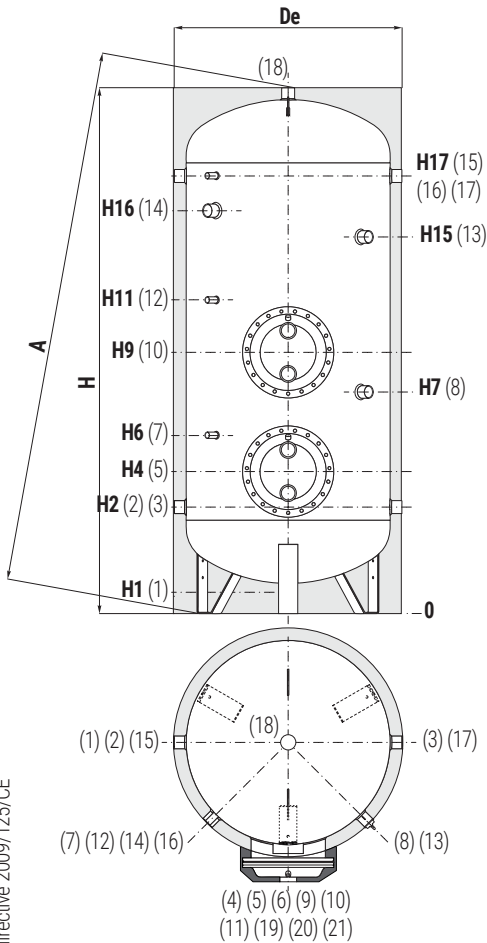
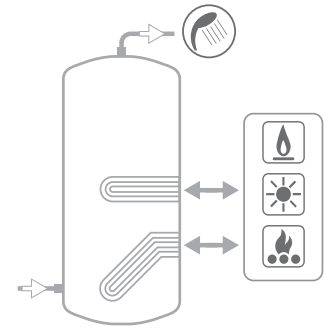

Models from 1500 to 5000 have two grippings on the bottom which allow the use of forklift when handling and drain pipe already fitted.

- | | |
|--------------|--|
| 1 | Drain 1" 1/4 F.
For model 1000 connection 1" 1/2 F |
| 2 | Domestic cold water circuit inlet |
| 3 | Alternative domestic cold water circuit inlet or connection for more boilers |
| 4 | Lower heat exchanger outlet 1" F
For models > 800 connection 2" F |
| 5 | Heat exchanger flange Lower |
| 6 | Lower heat exchanger inlet 1" F
For models > 800 connection 2" F |
| 7-12 | Connection for instrumentation 1/2" F |
| 8 | Connection for magnesium anode 1" 1/4 F |
| 9 | Upper heat exchanger outlet 1" F
For models > 800 connection 2" F |
| 10 | Heat exchanger flange Upper |
| 11 | Upper heat exchanger inlet 1" F
For models > 800 connection 2" F |
| 13 | Connection for 2 nd anode 1"1/4 Gas F (only for models > 1500) |
| 14 | Connection for electrical immersion 1" 1/2 F
For models > 800 connection 2" Gas F |
| 15-17 | Connection for recirculation or for domestic hot water |
| 16 | Connection for instrumentation 1/2" Gas F |
| 18 | Domestic hot water outlet |
| 19-20 | Heat exchangers air purge 3/8" Gas F |
| 21 | Drain 1" Gas F (only for models > 1000) |

HARD FOAM INSULATION (WXB)

Model	Volume Weight		De	H	A	H1	H2	H3	H4	H5	H6	H7	H8	H9	H10	H11	H15	H16	H17	5-10	2-3	
	[lt]	[kg]																			15-17	18
200	193	70	550	1449	1550	85	325	360	410	460	520	650	810	860	910	970	//	1075	1185	Øe 300	1"1/4	1"1/4
300	295	84	650	1499	1635	85	350	385	435	485	545	735	835	885	935	995	//	1100	1210	Øe 300	1"1/4	1"1/4
500	503	112	750	1800	1950	85	375	410	460	510	570	760	860	910	960	1020	//	1329	1485	Øe 300	1"1/4	1"1/4
800	799	177	900	2135	2320	85	405	450	540	630	690	870	1000	1090	1180	1240	//	1610	1765	Øe 380	1"1/4	1"1/4
1000	1047	226	1000	2221	2436	105	458	503	593	683	743	993	1053	1143	1233	1293	//	1664	1818	Øe 380	1"1/2	1"1/2
1500	1450	269	1100	2415	2654	109	440	585	675	765	825	1075	1160	1250	1340	1400	//	1895	2050	Øe 380	1"1/2	2"
2000	1985	337	1300	2492	2811	91	467	587	692	797	867	842	1157	1262	1367	1437	1952	1877	2057	Øe 430	2"	2"

SOFT FLEECE INSULATION (WXC)

Model	Volume Weight		De	H	A	H1	H2	H3	H4	H5	H6	H7	H8	H9	H10	H11	H15	H16	H17	5-10	2-3	
	[litres]	[kg]																			15-17	18
500	503	105	870	1841	1988	101	416	451	501	551	611	801	901	951	1001	1061	//	1370	1526	Øe 300	1"1/4	1"1/4
800	799	177	970	2188	2210	113	433	478	568	658	718	898	1028	1118	1208	1268	//	1638	1793	Øe 380	1"1/4	1"1/4
1000	1047	226	1070	2242	2260	101	454	499	589	679	739	989	1049	1139	1229	1289	//	1660	1814	Øe 380	1"1/2	1"1/2
1500	1450	269	1210	2440	2485	109	440	585	675	765	825	1075	1160	1250	1340	1400	//	1895	2050	Øe 380	1"1/2	2"
2000	1985	337	1360	2492	2560	91	467	587	692	797	867	842	1157	1262	1367	1437	1952	1877	2057	Øe 430	2"	2"
2500	2322	399	1350	2311	2470	140	551	671	776	881	951	976	1271	1376	1481	1551	1816	1732	1891	Øe 430	2"	2"
3000	2928	464	1350	2811	2940	140	551	731	836	941	1011	1036	1371	1476	1581	1651	2316	2232	2391	Øe 430	2"	2"
4000	3776	618	1500	2875	3040	114	570	750	855	960	1030	1035	1390	1495	1600	1670	2315	2238	2410	Øe 430	2"	2"
5000	4990	768	1700	2915	3120	94	580	750	855	960	1030	1035	1400	1505	1610	1680	2335	2265	2420	Øe 430	2"	2"

EXTRA2 - HEAT EXCHANGERS TECHNICAL DATA

Cordivari heat exchangers, with tubes bent to the bottom, are able to heat the complete quantity of volume in an homogeneous way. Energy storing is therefore improved and Ignition time data have to be referred to the complete volume of the tank, while in traditional straight heat exchangers equipped calorifires, a range between 9-17% of volume remains cold.

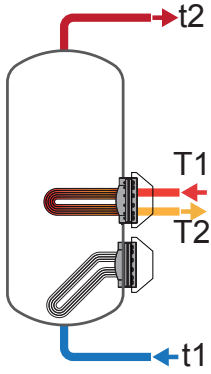

UPPER STRAIGHT HEAT EXCHANGERS

Model	Ignition time (minutes) from 10 °C to t2 and primary at T1				Maximum power exchange (kW) with primary at T1, secondary within 10-45 °C and constant use of DHW production				DHW continuous production lt/h within 10-45 °C and primary at T1			
	T1/t2				T1				T1			
	55/50	65/60	70/60	80/60	55	65	70	80	55	65	70	80
200	57	57	39	25	7	11	14	18	179	283	339	456
	74	75	52	33	6	9	11	14	142	219	259	344
300	57	57	39	25	11	18	21	28	275	436	521	702
	73	73	52	33	9	14	16	22	220	340	403	535
500	52	52	36	23	23	37	44	59	573	911	1090	1468
	66	55	46	30	19	29	35	46	468	724	857	1139
800	62	62	42	27	33	53	64	86	817	1312	1573	2129
	75	76	53	34	28	44	52	69	690	1079	1284	1715
1000	80	80	55	35	32	51	61	82	783	1252	1501	2029
	100	100	70	45	26	41	48	65	647	1008	1198	1599
1500	68	68	47	30	51	82	98	133	1259	2026	2430	3295
	82	83	57	37	44	68	81	109	1077	1690	2011	2687
2000	70	70	48	30	69	111	133	180	1702	2741	3293	4463
	84	85	59	37	59	93	111	148	1468	2306	2744	3668
2500	59	59	40	25	84	134	160	216	2069	3313	3969	5358
	71	72	50	32	71	111	131	174	1758	2738	3249	4318
3000	71	72	49	31	100	159	190	255	2465	3931	4698	6325
	88	89	62	40	84	130	154	204	2086	3229	3821	5057
4000	71	72	50	32	131	207	247	330	3242	5126	6112	8179
	89	90	63	41	110	168	198	260	2723	4167	4909	6448
5000	78	78	54	35	162	253	301	400	3998	6275	7459	9924
	99	100	71	46	135	204	239	312	3338	5055	5930	7735

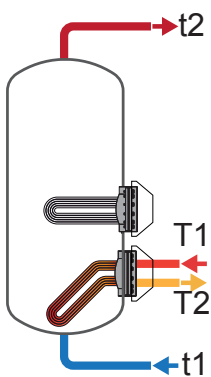

CURVED HEAT EXCHANGERS

Model	Ignition time (minutes) from 10 °C to t2 and primary at T1				Maximum power exchange (kW) with primary at T1, secondary within 10-45 °C and constant use of DHW production				DHW continuous production lt/h within 10-45 °C and primary at T1			
	T1/t2				T1				T1			
	55/50	65/60	70/60	80/60	55	65	70	80	55	65	70	80
200	113	113	77	49	7,3	12	14	18	178	283	338	455
	147	148	102	65	6	9	11	13,9	141	218	258	344
300	112	113	76	48	11	17	21	28	274	435	520	701
	145	146	102	65	9	14	16	21,6	219	339	402	534
500	90	90	62	39	23	37	44	59	571	909	1088	1467
	114	115	80	51	19	29	35	46	466	722	856	1137
800	101	101	69	44	33	53	64	86	815	1310	1572	2128
	124	125	86	55	28	44	52	69	688	1077	1282	1712
1000	82	83	56	36	51	82	98	133	1257	2024	2429	3293
	101	100	69	44	44	68	81	108	1076	1689	2010	2685
1500	120	119	82	51	51	81	98	133	1256	2022	2428	3290
	145	146	100	64	44	68	81	108	1075	1687	2008	2684
2000	121	122	83	52	69	111	133	180	1699	2738	3288	4453
	146	147	101	65	59	93	111	148	1465	2302	2741	3665
2500	118	119	81	51	69	111	133	180	1699	2738	3288	4453
	145	146	101	65	59	93	111	148	1465	2302	2741	3665
3000	128	127	87	55	100	159	190	255	2461	3926	4694	6321
	456	157	110	70	84	130	154	204	2082	3224	3817	5053
4000	126	127	87	56	131	207	247	330	3236	5121	6105	8168
	159	161	112	73	110	168	198	260	2718	4151	4903	6443
5000	137	138	96	61	162	253	301	401	3992	6270	7450	9921
	176	179	125	82	135	204	239	312	3332	5049	5923	7727

EXTRA2 - HEAT EXCHANGERS TECHNICAL DATA

Data have been calculated on following basis:

- 1) Primary circuit at T1 and proper energy source;
- 2) Production of DHW in continue way from 10 °C at t2;
- 3) DHW that can be taken in the first 10' and in the first hour from storage at 60°C, input 10°C and output 45°C;
- 4) Sanitary water according to UNI CTI 8065.

DHW produced in the first 10 minutes in lt/10' input 10 °C output 45 °C, storage at t2 and primary at T1				DHW produced in the first hour in lt/60' input 10 °C output 45 °C, storage at t2 and primary at T1				Flow rate	Exchanger pressure loss	
T1/t2				T1/t2					[m³/h]	[mm.H ₂ O]
55/50	65/60	70/60	80/60	55/50	65/60	70/60	80/60			
140	184	194	213	253	364	408	502	2	294,35	28,9
133	174	180	194	223	312	344	412	1	80,5	7,9
215	284	298	328	389	560	628	773	3	355,7	34,9
206	268	279	301	345	483	534	639	1,5	95,97	9,4
418	555	585	648	781	1132	1275	1577	6	682	66,9
400	524	546	593	697	982	1088	1314	3	179	17,6
689	910	954	1046	1207	1741	1950	2395	10	1311	128,6
668	871	905	977	1105	1555	1719	2063	5	341	33,4
816	1066	1107	1195	1312	1859	2058	2480	10	1311	128,6
794	1025	1057	1124	1203	1664	1816	2136	5	341	33,4
1149	1512	1579	1723	1947	2795	3118	3810	15	2181	213,9
1119	1456	1509	1622	1801	2526	2783	3324	7,5	560	54,9
1595	2095	2187	2382	2672	3831	4273	5209	20	2846	279,1
1556	2023	2096	2250	2485	3483	3834	4573	10	728	71,4
1652	2186	2296	2527	2963	4285	4809	5921	20	2314	226,9
1600	2091	2176	2354	2714	3825	4233	5089	10	592	58,1
2303	3021	3149	3420	3865	5511	6124	7426	20	2745	269,2
2240	2904	3003	3209	3561	4949	5423	6411	10	700	68,6
2972	3894	4059	4403	5026	7141	7930	9583	20	3701	362,9
2886	3735	3858	4115	4610	6374	6967	8198	10	939	92,1
3882	5066	5263	5674	6414	9040	9987	11959	20	4472	438,6
3772	4863	5008	5309	5886	8064	8764	10208	10	1132	111,0

DHW produced in the first 10 minutes in lt/10' input 10 °C output 45 °C, storage at t2 and primary at T1				DHW produced in the first hour in lt/60' input 10 °C output 45 °C, storage at t2 and primary at T1				Flow rate	Exchanger pressure loss	
T1/t2				T1/t2					[m³/h]	[mm.H ₂ O]
55/50	65/60	70/60	80/60	55/50	65/60	70/60	80/60			
247	319	328	347	360	498	542	635	2	309	30,3
241	308	314	329	330	446	478	547	1	84,74	8,3
371	480	494	524	545	755	823	968	3	372	36,5
362	464	474	496	501	678	729	834	1,5	101,02	9,9
649	844	874	937	1011	1420	1563	1866	6	718	70,4
632	813	836	882	927	1270	1378	1602	3	189,22	18,6
1039	1347	1391	1483	1555	2177	2386	2831	10	1380	135,3
1018	1308	1342	1414	1453	1990	2154	2498	5	358,5	35,2
1347	1759	1826	1970	2143	3041	3365	4056	15	2295	225,1
1316	1703	1756	1869	1998	2773	3029	3569	7,5	589,6	57,8
1855	2394	2462	2605	2651	3675	4000	4689	15	2295	225,1
1825	2338	2392	2504	2506	3407	3664	4204	7,5	589,6	57,8
2546	3285	3377	3571	3622	5019	5459	6391	20	2996	293,8
2507	3212	3285	3439	3435	4670	5021	5761	10	766,42	75,2
2927	3761	3852	4046	4003	5495	5935	6867	20	2436	238,9
2888	3688	3761	3915	3815	5146	5497	6236	10	624	61,2
3748	4827	4955	5226	5307	7314	7928	9230	20	2836	278,1
3685	4710	4809	5015	5004	6752	7226	8215	10	723	70,9
4842	6232	6396	6740	6892	9475	10263	11913	20	3896	382,1
4756	6070	6196	6452	6477	8699	9301	10533	10	989	97,0
6362	8166	8363	8775	8891	12137	13081	15058	20	4707	461,6
6252	7963	8109	8409	8363	11161	11860	13303	10	1192	116,9

EXTRA2 - PRESSURE LOSS - LOWER CURVED HEAT EXCHANGERS



Lower heat exchanger surface [m²]

200	0,5
300	0,75
500	1,5
800	2
1000	3
1500	3
2000	4
2500	5
3000	6
4000	8
5000	10



Chart for surfaces of: 0,5 m² / 0,75 m² / 1 m²

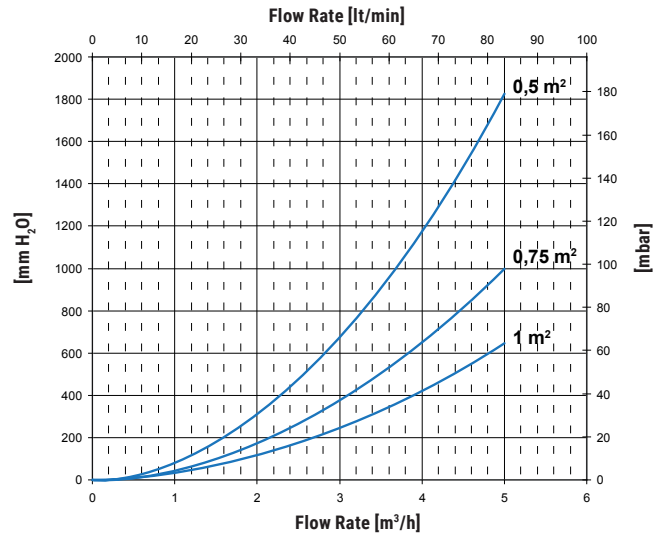

Chart for surfaces of: 1,5 m² / 2 m² / 3 m²

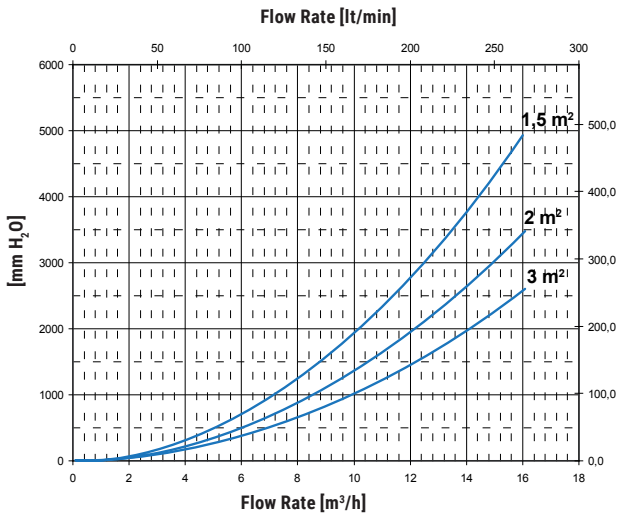

Chart for surfaces of: 4 m² / 5 m²

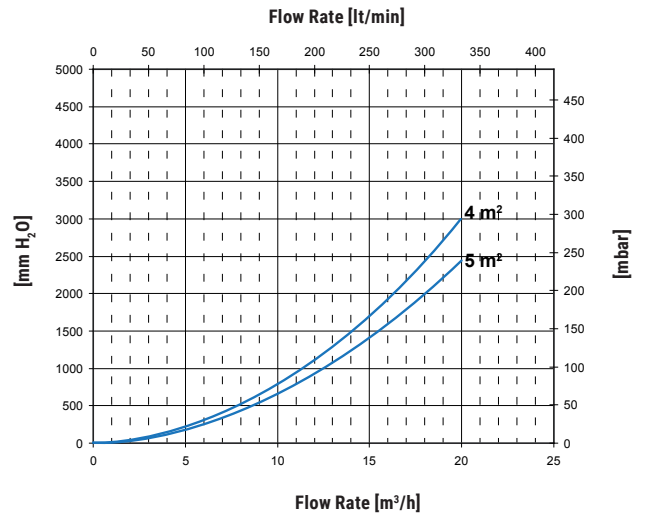

Chart for surfaces of: 6 m² / 8 m²

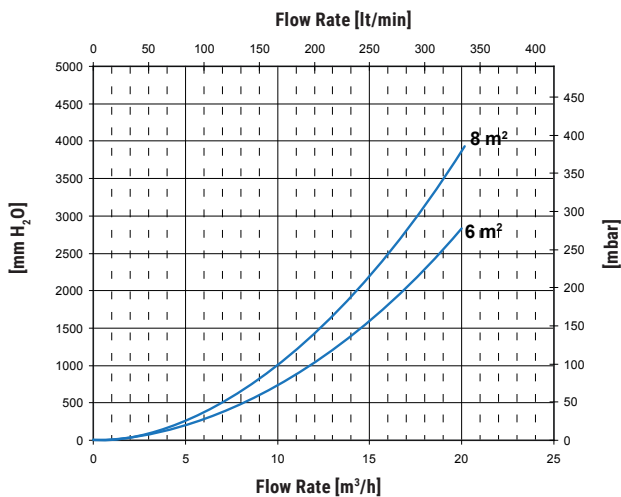
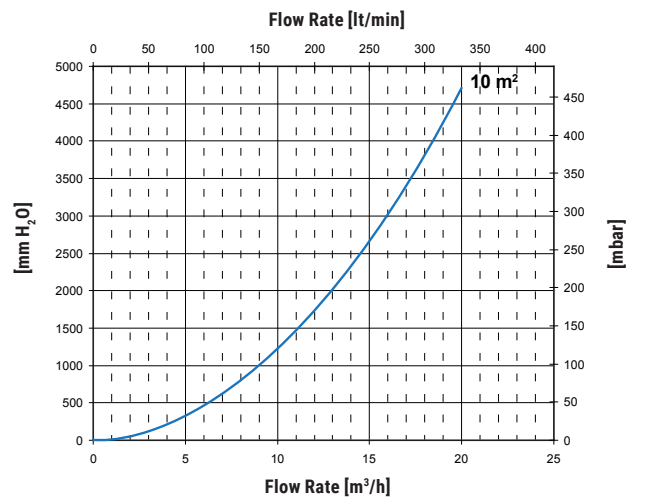

Chart for surfaces of: 10 m²



EXTRA2 - PRESSURE LOSS - UPPER STRAIGHT HEAT EXCHANGERS



POLYWARM®



Upper heat exchanger surface [m²]

200	0,5
300	0,75
500	1,5
800	2
1000	2
1500	3
2000	4
2500	5
3000	6
4000	8
5000	10

Chart for surfaces of: 0,5 m² / 0,75 m² / 1 m²

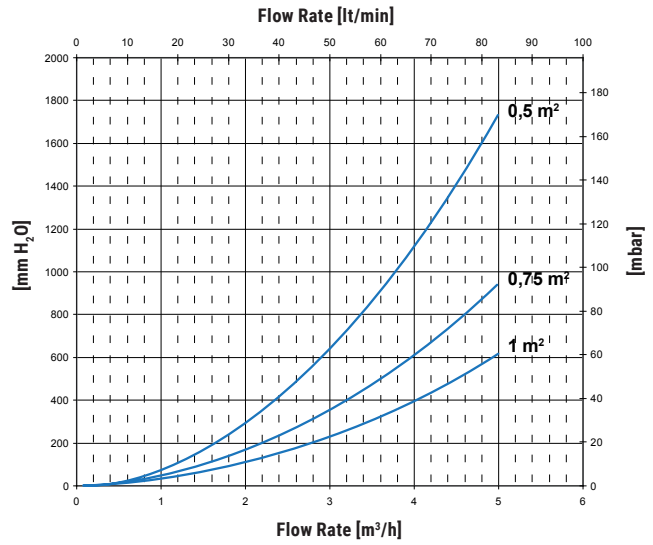

Chart for surfaces of: 1,5 m² / 2 m² / 3 m²

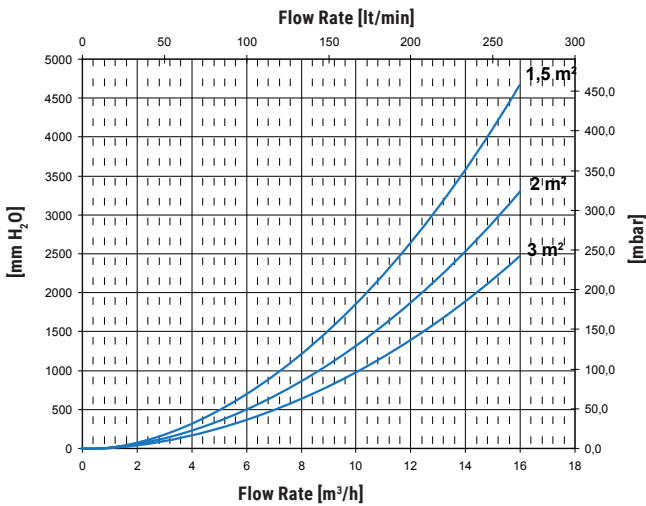

Chart for surfaces of: 4 m² / 5 m²

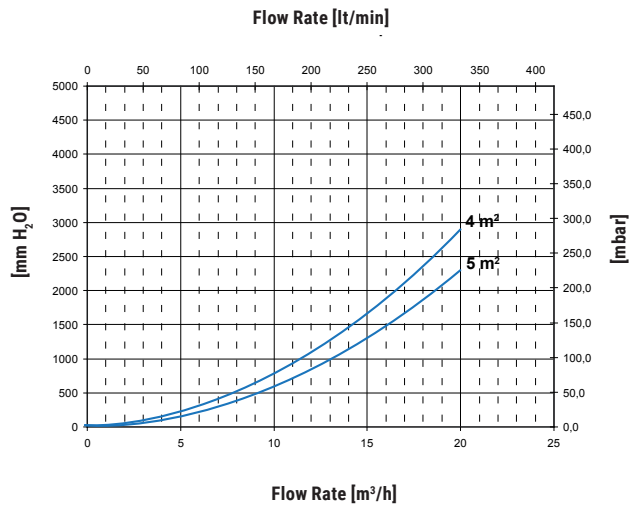

Chart for surfaces of: 6 m² / 8 m²

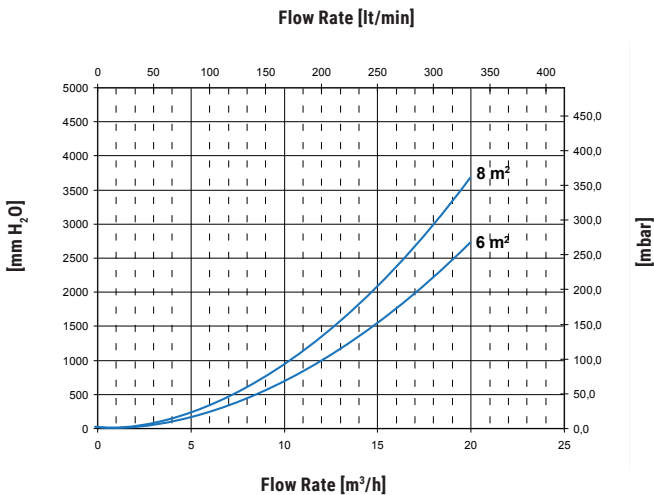

Chart for surfaces of: 10 m²

